

ANBAUANLEITUNG

mounting instructions • instructions de montage • instrucciones de montaje • istruzioni di montaggio

HPR.00.666.41100/OR

beinhaltet • contains • contient • contiene • contiene

BHG-152-00-NP

Preparation

If the handlebar grips are not open at the end they will need to be cut open for the handguard to be fitted. Use a sharp knife to cut a hole in the end of each handgrip. On the right side the hole size should be neat and no smaller than the inside diameter of the throttle tube. Loosen the throttle assembly to move it outward about 20mm. Roll back the end of the grip and use a hacksaw to carefully cut off the end cap of the plastic throttle tube. Do not remove more than 3mm and take care not to cut the underlying handlebar. Before refitting, remove any burrs that could restrict throttle movement.

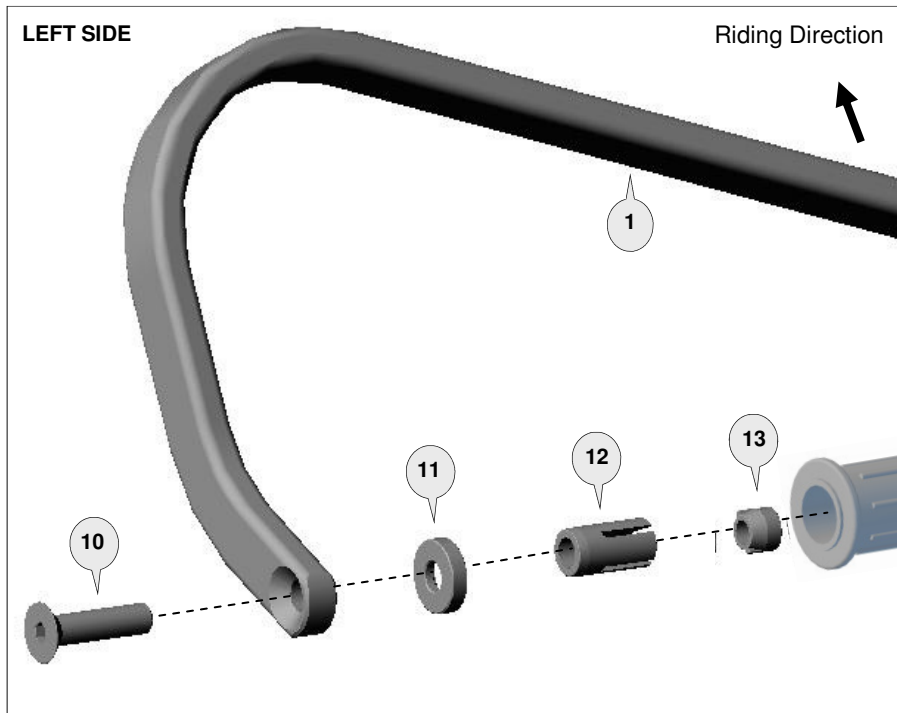

Installation for Left Side.

Repeat for right side with applicable parts.

Loosely assemble the clamp to the handlebar as per diagram. Attach the handguard backbone with applicable parts to the handlebar end and also to the clamp connector (4).

Position backbone so it is horizontal when viewed from the side and tighten all bolts in the following order: (10), (8), (7) then (6).

Note: Most handlebars will require left connector (4) on left side. **Magura** and some other handlebars will require right connector (5) on left side.

Important: Use the specified torque setting over page.

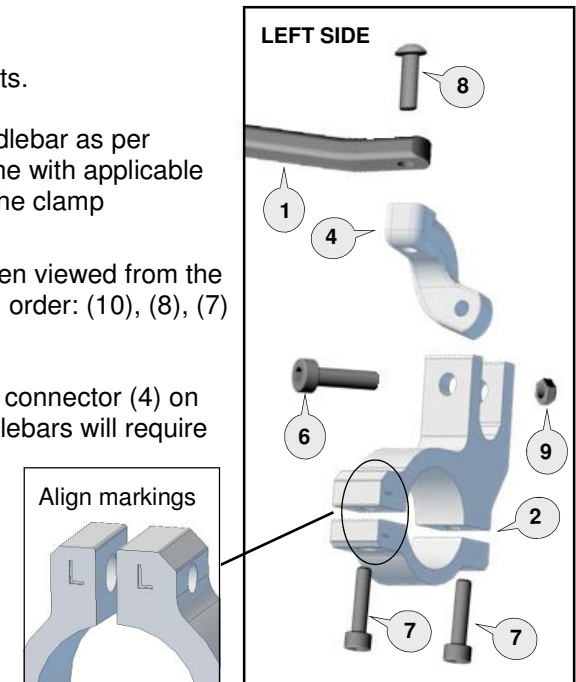

Bar Side View

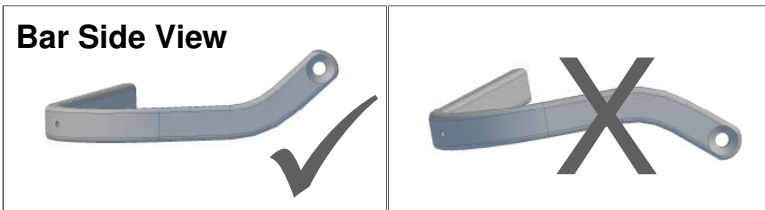

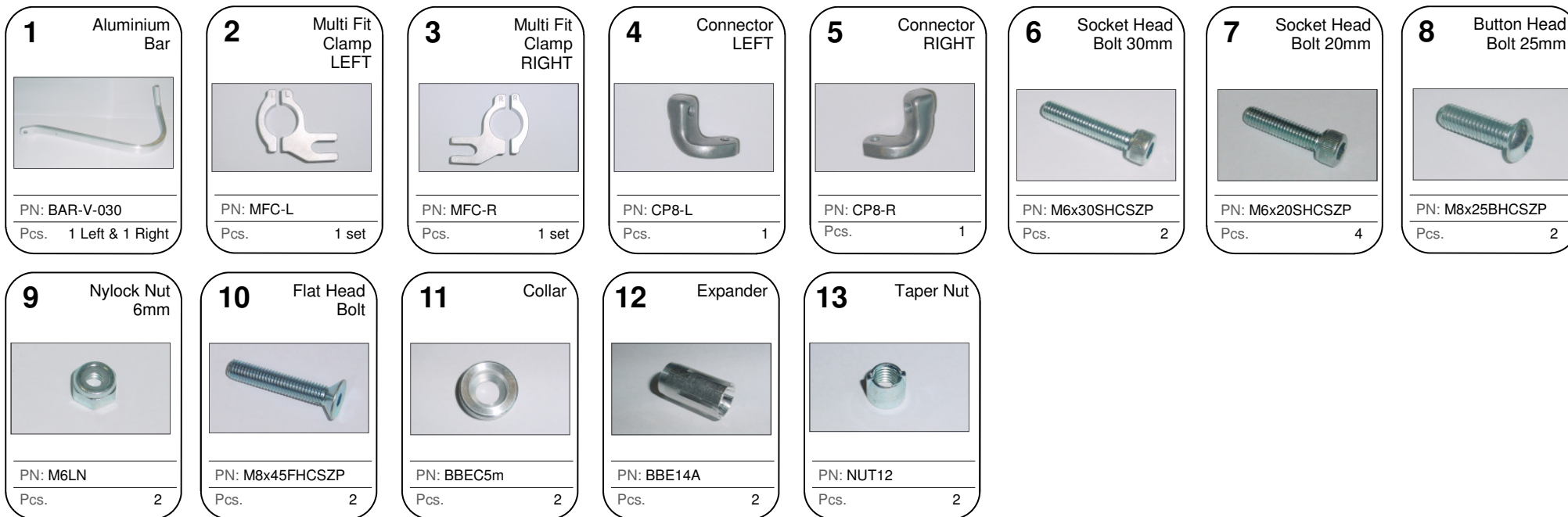

Recommended Torque Settings	
M6	10 Nm (7.4 lbf ft)
M8	20 Nm (14.8 lbf ft)

CAUTION:

Installation of the handguard is safety-relevant work and can be complicated. We recommend the installation be performed by a motorcycle service technician. Rideworx accepts no liability for damages caused by improper mounting. All screws, bolts and nuts, including all replacement hardware provided by Rideworx, should be tightened to the torque specified in the below table. After the first 50km of riding check all screws, bolts and nuts are tightened to the correct torque. We recommend a medium strength liquid thread lock product on all fasteners.

WARNING:

It is important there is a working clearance (approx 3mm) between the throttle grip end and the handguard to ensure a free closing throttle. Check operation of all handlebar controls, specifically the throttle, front brake, kill switch and clutch to ensure they are operating correctly and are in accordance with the OEM specifications. Do not ride the motorcycle if any controls are not operating correctly. Check periodically that all bolts are tight.



Phone: +61 (0)2 4271 8244
 Email: info@barkbusters.net
 Web: www.barkbusters.net



Disclaimer:

A failure to follow these fitting instructions could cause serious injury, death or property damage. These handguards are intended solely for use with motorcycles/ATV/snowmobiles/scooters that have not been modified. They are not designed to prevent injury or death while riding or in an accident or crash. The user must ensure that all controls are free of the handguards every time that they ride. By installing and/or using this product you acknowledge that you accept these terms and have followed the fitting instructions.



Fitment to KTM 790 Adventure/R (2019)

UNIVERSAL TAPERED HARDWARE

JET-002 or BHG-152

NOTE:

- ⇒ Requires additional 10mm spacer & bolt **B-078**
- ⇒ Requires handlebar to be set in standard centre position or back position.
- ⇒ Forward handlebar position may cause interference with instruments at full steering lock.



Without 10mm spacer applying the brake may cause lever to contact alloy backbone

Shown with brake lever fully engaged



With 10mm spacer included applying the brake allows lever to operate freely.

Shown with brake lever fully engaged



Handlebar in most forward position may cause interference at full steering lock (not recommended)

Recommendation is for handlebar to be in centre or rear position

NB: if handlebar is in centre position and then "rolled" forward it may cause handguards to touch the instruments at full steering lock (precise handguard height & position will affect this)

For all available recommendations go to **WWW.BARKBUSTERS.NET** "What fits my bike"

<https://barkbusters.net/what-fits-my/ktm/790-adventure-r-2019-on/>



www.barkbusters.net

FITTING INSTRUCTIONS for BHG-152 Handguard on...

- KLZ 1000 VERSYS (2015-2018)

Preparation

Remove original handlebar end weight.

Note: Items 11, 12 and 13 are not required for this application.

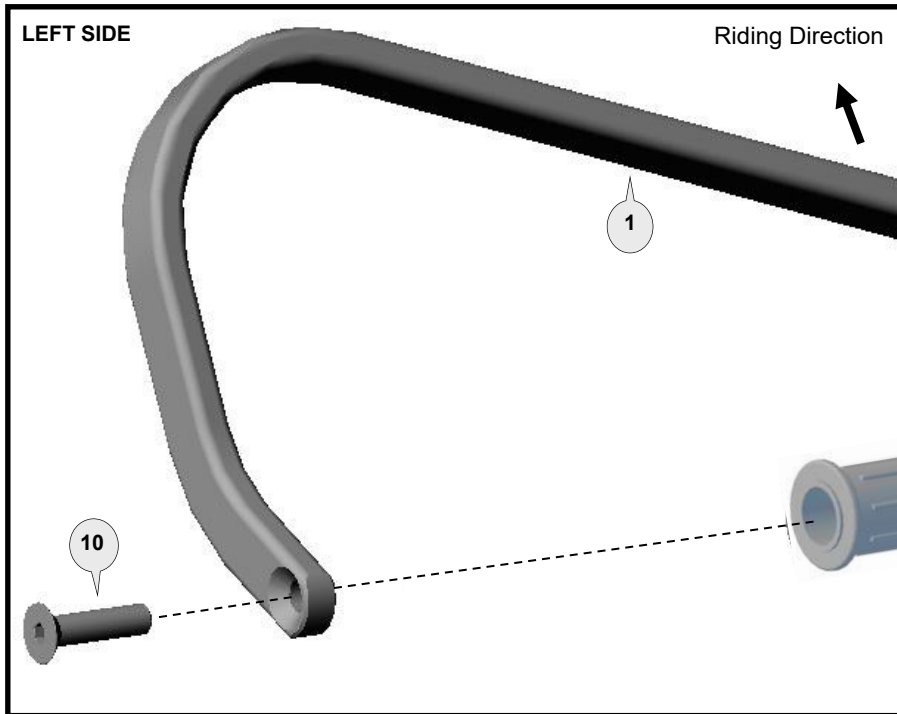

Installation for Left Side.

Repeat for right side with applicable parts.

Loosely assemble the clamp to the handlebar as per diagram. Attach the handguard backbone directly to the handlebar end with bolt (10) and also to the clamp connector (4) with bolt (8).

Position backbone so it is horizontal when viewed from the side and tighten all bolts in the following order: (10), (8), (7) then (6).

Important: Use the specified torque setting over page.

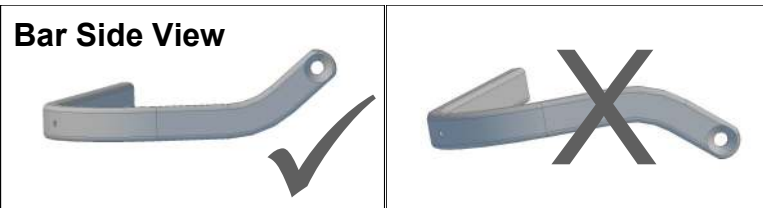
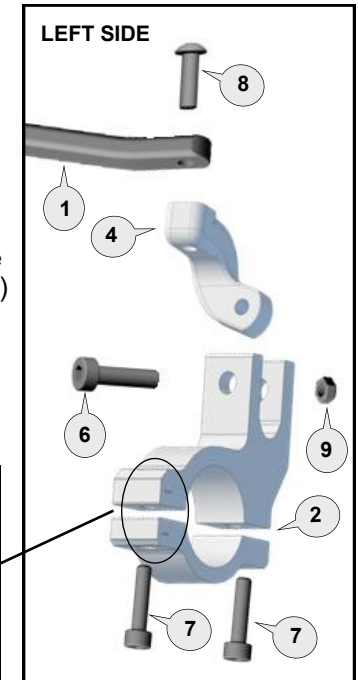

Personalise Your Protection

Guard options sold separately

JET	JET-003
VPS	VPS-003
Storm	STM-003
CARBON	BCF-003



Phone: +61 (0)2 4271 8244
Email: info@barkbusters.net

1 Aluminium Bar



PN: BAR-V-030
Pcs. 1 Left & 1 Right

2 Multi Fit Clamp LEFT



PN: MFC-L
Pcs. 1 set

3 Multi Fit Clamp RIGHT



PN: MFC-R
Pcs. 1 set

4 Connector LEFT



PN: CP8-L
Pcs. 1

5 Connector RIGHT



PN: CP8-R
Pcs. 1

6 Socket Head Bolt 30mm



PN: M6x30SHCSZP
Pcs. 2

7 Socket Head Bolt 20mm



PN: M6x20SHCSZP
Pcs. 4

8 Button Head Bolt 25mm



PN: M8x25BHCSZP
Pcs. 2

9 Nylock Nut 6mm



PN: M6LN
Pcs. 2

10 Flat Head Bolt



PN: M8x45FHCSZP
Pcs. 2

11 Collar



PN: BBEC5m
Pcs. 2

12 Expander



PN: BBE14A
Pcs. 2

13 Taper Nut



PN: NUT12
Pcs. 2

Recommended Torque Settings	
M6	10 Nm (7.4 lbf ft)
M8	20 Nm (14.8 lbf ft)

CAUTION:

Installation of the handguard is safety-relevant work and can be complicated. We recommend the installation be performed by a motorcycle service technician. Rideworx accepts no liability for damages caused by improper mounting. All screws, bolts and nuts, including all replacement hardware provided by Rideworx, should be tightened to the torque specified in the below table. After the first 50km of riding check all screws, bolts and nuts are tightened to the correct torque. We recommend a medium strength liquid thread lock product on all fasteners.

WARNING:

It is important there is a working clearance (approx 3mm) between the throttle grip end and the handguard to ensure a free closing throttle. Check operation of all handlebar controls, specifically the throttle, front brake, kill switch and clutch to ensure they are operating correctly and are in accordance with the OEM specifications. Do not ride the motorcycle if any controls are not operating correctly. Check periodically that all bolts are tight.



Phone: +61 (0)2 4271 8244
Email: info@barkbusters.net
Web: www.barkbusters.net



Disclaimer:

A failure to follow these fitting instructions could cause serious injury, death or property damage. These handguards are intended solely for use with motorcycles/ATV/snowmobiles/scooters that have not been modified. They are not designed to prevent injury or death while riding or in an accident or crash. The user must ensure that all controls are free of the handguards every time that they ride. By installing and/or using this product you acknowledge that you accept these terms and have followed the fitting instructions.