

Kettenschutz YAMAHA XT 660 Z Ténéré
Chain Guard YAMAHA XT 660 Z Ténéré

Montagehinweise

Alle vom Motorrad gelösten Schrauben sind gemäß Herstellerangaben wieder zu montieren, oder mit von SW-MOTECH gelieferten Schrauben zu ersetzen. Falls nicht anderweitig definiert, diese Schrauben nach Tabelle anziehen:

M5 5,5 Nm

Gegebenenfalls Schrauben mit flüssiger Schraubensicherung einkleben.

Prüfen Sie nach 50 km alle Verbindungen auf festen Sitz.

Mounting Instructions

SW-MOTECH products should be installed by a qualified, experienced motorcycle technician. If you are unsure of your ability to properly install a product, please have the product installed by your local motorcycle dealer. SW-MOTECH takes no responsibility for damages caused by improper installation.

All screws, bolts and nuts, including all replacement hardware provided by SW-MOTECH, should be tightened to the torque specified in the OEM maintenance manual for your motorcycle. If no torque specifications are provided in the OEM maintenance manual, the following torques may be used:

M5 5,5 Nm





All screws, bolts and nuts should be checked after driving the first 50 km to ensure that all are tightened to the proper torque.

Medium strength liquid thread-locker (i.e., "Loctite") should be used to secure all screws, bolts and nuts.

SW-MOTECH GmbH & Co. KG
Bahnhofstrasse 44d
35282 Rauschenberg
Germany

Tel.: ++ 49 (0) 6425 816 800
Fax: ++ 49 (0) 6425 816 810

www.sw-motech.com

<p>1 Kettenschutz Chain Guard</p>  <p>KTS.06.190.001</p> <p>Anzahl/ Pcs. 1</p>	<p>2 Bundbuchse M5 Bushing M5</p>  <p>BB.140.080.052.064.052.01</p> <p>Anzahl/ Pcs. 3</p>	<p>4 Senkkopfschraube Countersunk Screw</p>  <p>M5 x 16 DIN 7991</p> <p>Anzahl/ Pcs. 3</p>
<p>3 Gummitülle Rubber Element</p>  <p>GT.12H3468</p> <p>Anzahl/ Pcs. 3</p>	<p>5 Senkscheibe Countersunk Washer</p>  <p>SE.00.053.01</p> <p>Anzahl/ Pcs. 3</p>	

Schritt
Step 1

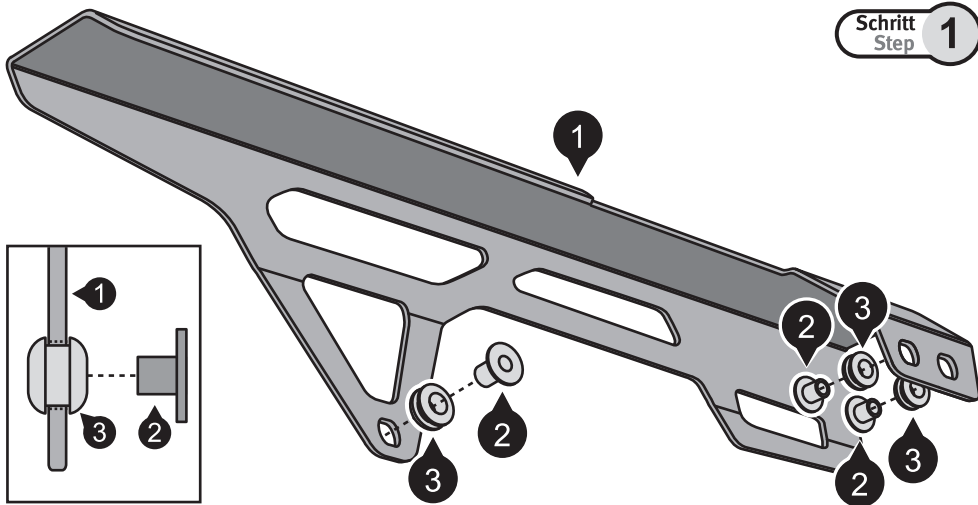

Fahrtrichtung
Driving direction

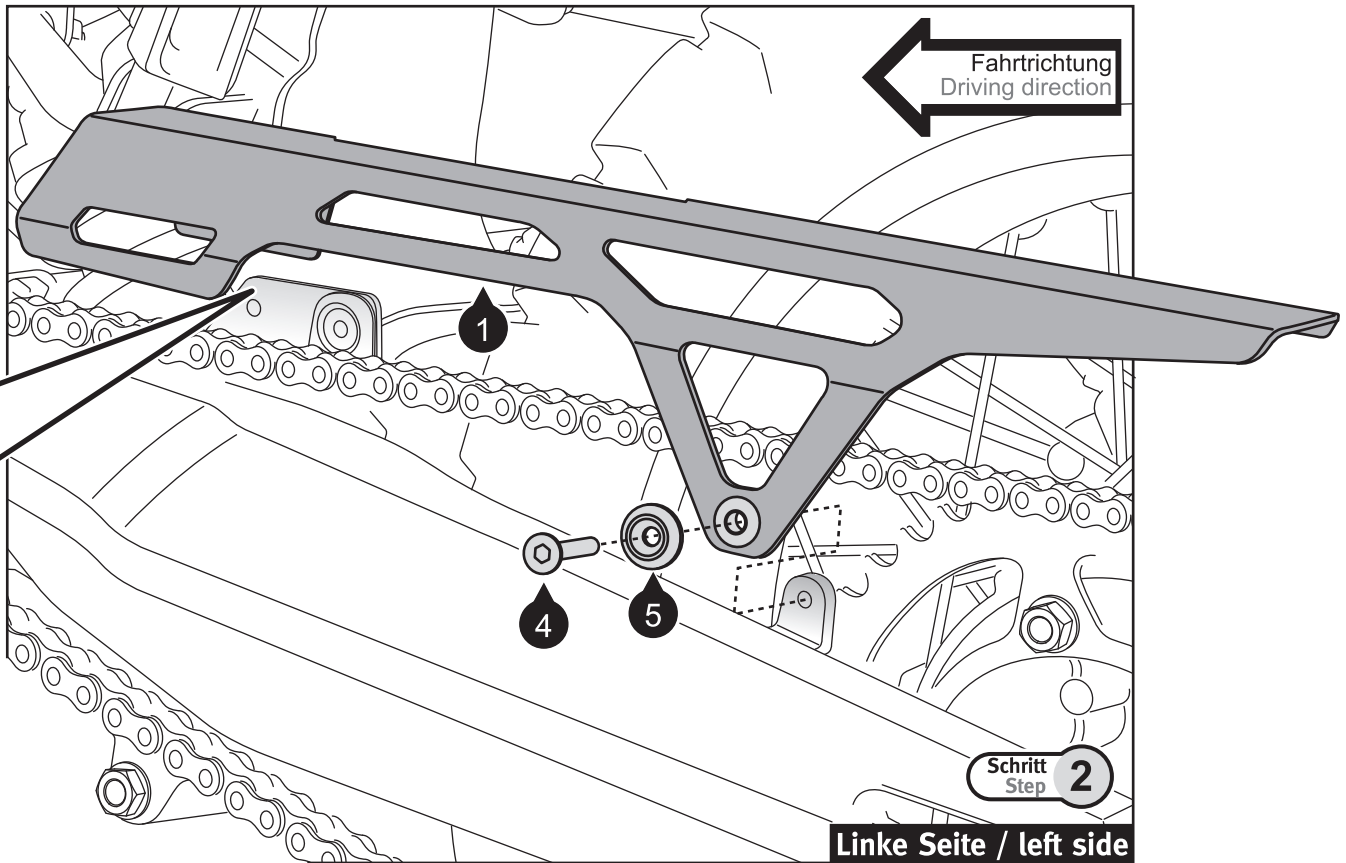
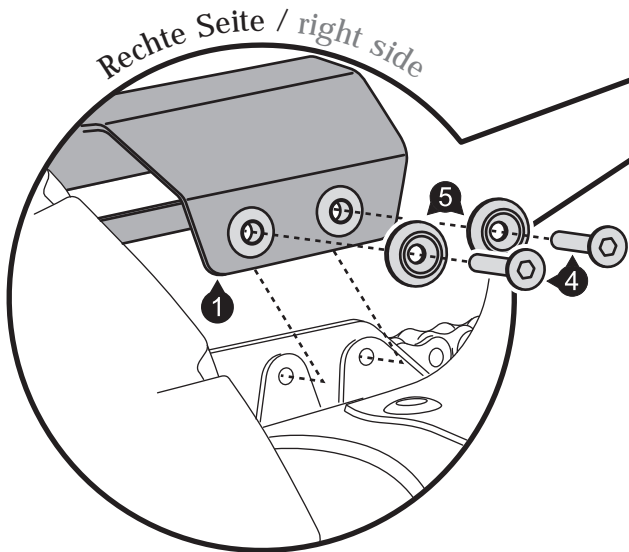

Schritt
Step 2

Linke Seite / left side